

Fiber Media Converter

1 Optic & 1 Ethernet ; -30°C~ +75°C ; Single Mode Single Core



Main Feature

- * Industrial-Grade Protection
- * Dust-Proof Excellent Heat Dissipation
- * CPU Runs Stable
- * -30°C~ +75°C Wide Temperature
- * Install Neat Beauty
- * Plug & Play



Plug & Play

Plug & Play

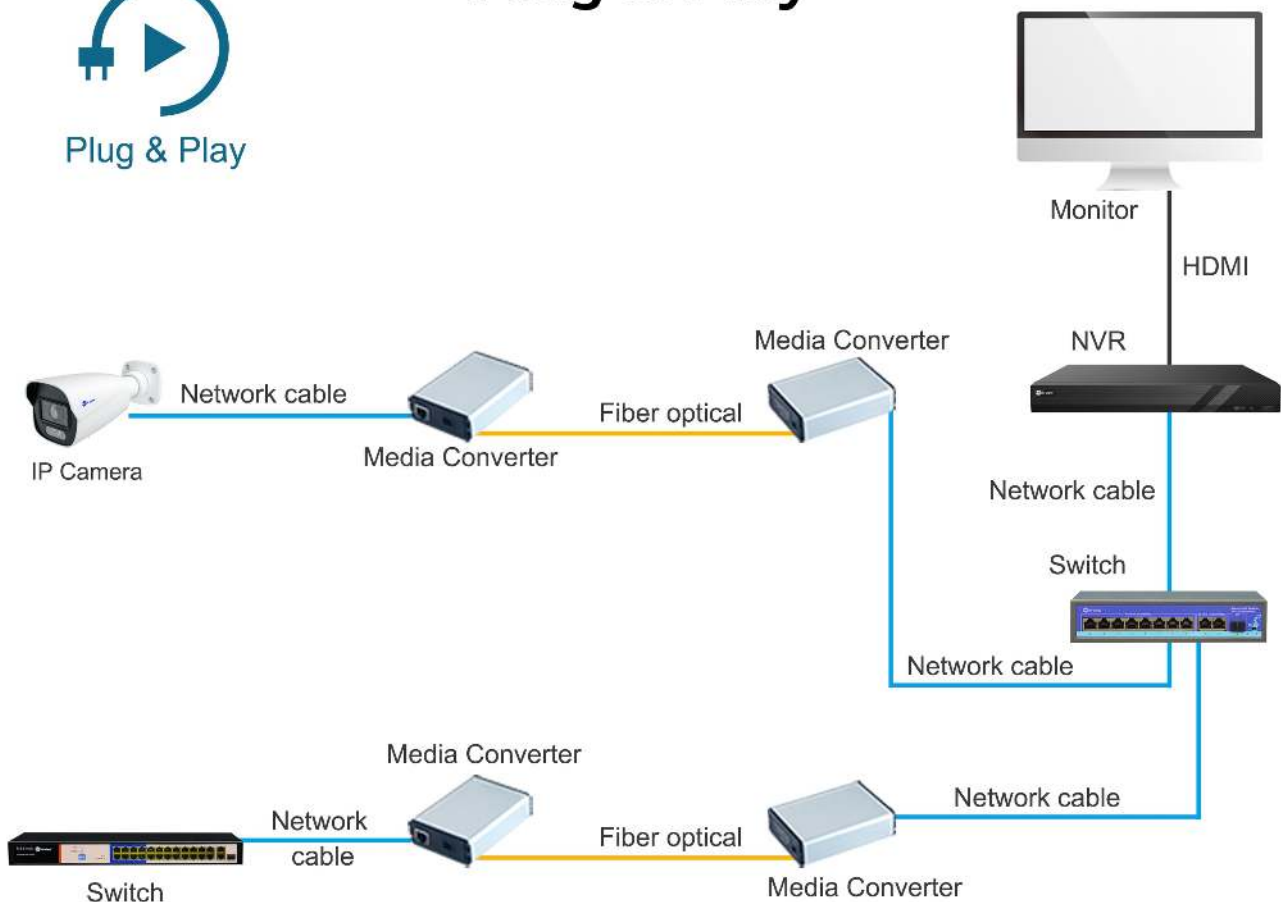

Fiber Media Converter

1 Optic & 1 Ethernet ; -30°C~ +75°C ; Single Mode Single Core



Link Way

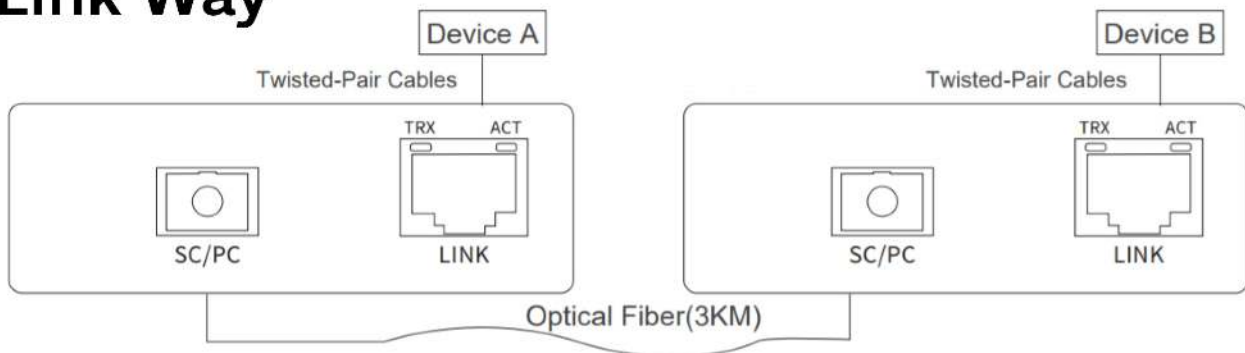

Specification

Model	HG-FCS3AB(IN)
Protocol Standard	IEEE802.3z/ab
Network Interface	RJ45 10/100/1000Mbps Self-Adaption
	Transmission Distance: 100m
Fiber Interface	Single Mode SC/PC
	Optical Fiber Type: Single Mode 9/125μm
	1310T/1550R
	Transmission Rate: 1000Mbps
	Transmission Distance: ≤3KM
Performance & Specification	Forwarding Mode: Store Forward
	Transfer Mode: Full Duplex
	Full Duplex Automatic Connection
	Network Latency: ≤150μs
Power	Power Type: External Power
	Power Input: DC5V 1A or 12V 0.4A
	DC Socket: 2.5x5.0 mm
Working Environment	Working Temperature: -30°C ~ 75°C
	Storage Temperature: -10°C ~ 55°C
Physical Specifications	Size: 70x26x93 mm / Fuselage Color: Silver